

Making cooking as much fun as eating

Please read this instruction manual. Then you will be able to use all the technical advantages your cooker has to offer.

It will provide you with important safety information. You will then be familiarised with the individual parts of your new cooker. And we will show you how to make settings step by step - simple!

The tables list the settings and shelf positions for numerous well-known dishes, all of which are tested in our cooking studio.

In the unlikely event of a malfunction, look here for information on how to rectify minor faults yourself.

A detailed table of contents will help you to find your way around quickly.

Enjoy your meal!

Instruction manual

HBN 13B2.1 B

en

9000 275 926

Table of contents

Safety information	4
Before installation	4
Information for your safety	4
Causes of damage	6
Your new oven	7
Control panel	7
Buttons and display	8
Function and temperature selector	8
Function selector	9
Temperature selector	9
Cooking compartment	10
Accessories	10
Before using the appliance for the first time ...	14
Setting the clock	14
Heating up the oven	14
Cleaning accessories	15
Setting the oven	15
Type of heating and temperature	15
Setting the time-setting options	17
Timer	17
Cooking time	18
End time	20
Time	22
Childproof lock	23
Changing the basic settings	24

Table of contents

Care and cleaning	25
Cleaning agents	25
Cleaning hook-in racks	27
Detaching and attaching the oven door	28
Cleaning the door panels	30
Troubleshooting	32
Malfunction table	32
Replacing the oven light	33
Glass cover	35
After-sales service	35
Energy and environment tips	36
Saving energy	36
Environmentally friendly disposal	36
Tested for you in our cooking studio	37
Cakes and pastries	37
Baking tips	41
Meat, poultry, fish	42
Tips for roasting and grilling	47
Preprepared products	48
Special dishes	49
Defrosting	50
Drying	51
Acrylamide in foodstuffs	52
Test dishes	53

Safety information

Read this instruction manual carefully. Please keep the instruction and installation manuals in a safe place. Please pass on these manuals to the new owner if you sell the appliance.

Before installation

Transport damage

Check the appliance for damage after unpacking it. Do not connect the appliance if it has been damaged in transport.

Electrical connection

Only allow a licensed professional to connect the appliance. Damage caused by incorrect connection is not covered under warranty.

Information for your safety

This appliance is intended for domestic use only. This appliance must only be used for food preparation.

Adults and children must not operate the appliance without supervision,

- if they are physically or mentally incapable of doing so or
- if they lack the knowledge and experience.

Never let children play with the appliance.

Hot cooking compartment

There is a risk of burns.

Never touch the interior surfaces of the cooking compartment or the heating elements. Open the appliance door carefully. Hot steam may escape. Small children must be kept at a safe distance from the appliance.

There is a risk of fire.

Never store combustible items in the cooking compartment.

Never open the appliance door if there is smoke inside. Switch off the appliance. Pull out the mains plug or switch off the appliance by the fuse in the fuse box.

There is a risk of short-circuiting.

Never trap connecting cables of electrical appliances in the hot appliance door. The cable insulation could melt.

There is a risk of scalding

Never pour water into the hot cooking compartment. This will cause hot steam.

There is a risk of burns.

Never prepare food containing large quantities of drinks with a high alcohol content. Alcoholic vapours can catch fire in the cooking compartment. Only use small quantities of drinks with a high alcohol content and open the appliance door carefully.

Hot accessories and ovenware

There is a risk of burns.

Never remove ovenware and accessories from the cooking compartment without an oven cloth or oven gloves.

Incorrect repairs

There is a risk of electric shock.

Incorrect repairs are dangerous. Repairs may only be carried out by one of our experienced after-sales engineers.

If the appliance is defective, pull out the mains plug or switch off the appliance by the fuse in the fuse box. Call the after-sales service.

Causes of damage

Accessories, foil, greaseproof paper or ovenware on the cooking compartment floor

Do not place accessories on the cooking compartment floor. Do not cover the cooking compartment floor with any sort of foil or greaseproof paper. Do not place ovenware on the cooking compartment floor if a temperature of over 50 °C is set.

This will cause heat accumulation. The baking and roasting times will no longer be correct and the enamel will be damaged.

Water in the hot cooking compartment

Never pour water into the hot cooking compartment. This will cause steam. The temperature change can cause damage to the enamel.

Moist food

Do not store moist food in the closed cooking compartment for long periods. This will damage the enamel.

Fruit juice

When baking very moist fruit flan, do not put too much on the baking tray. Fruit juice dripping from the baking tray leaves stains that cannot be removed. If possible, use the deeper universal pan.

Cooling with the oven door open

Only leave the cooking compartment to cool with the door closed. Even if you only leave the oven door open slightly, the fronts of adjacent units may become damaged over time.

Very dirty oven seal

If the oven seal is very dirty, the oven door will no longer close properly when the oven is in use. The fronts of adjacent units could be damaged. Always keep the oven seal clean.

Oven door as a seat or storage space

Do not stand or sit on the open oven door. Do not place ovenware or accessories on the oven door.

Transporting the appliance

Do not carry or hold the appliance by the door handle. The door handle cannot support the weight of the appliance and could break.

Your new oven

Here you can familiarise yourself with your new oven. The control panel and the individual controls are explained here. You will find information about the cooking compartment and the accessories.

Control panel

Here is an overview of the control panel. The display never shows all of the symbols at the same time. Details may vary, depending on the appliance model.

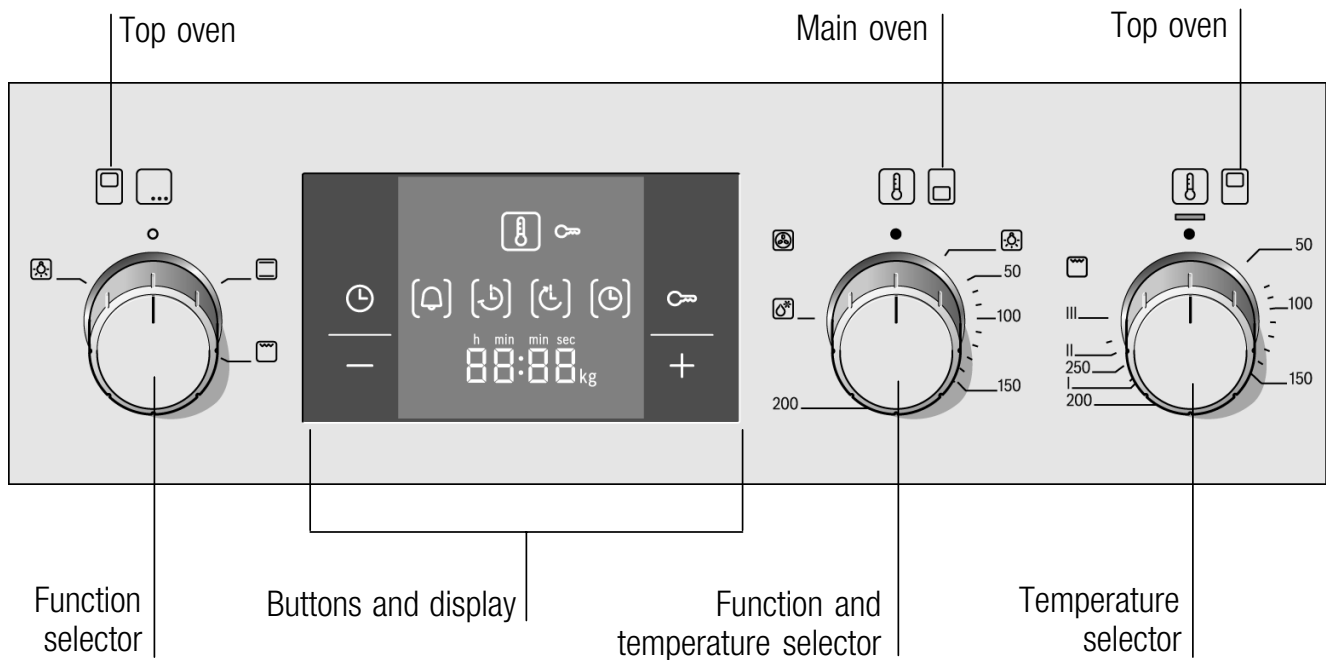

Control knobs







The control knobs can be popped out. Simply press the control knob when it is in the off position to pop it in or out.

Buttons

Sensors are located under the individual buttons. They do not need to be pressed firmly. Simply touch the corresponding symbol.

Buttons and display

You can use the buttons to set various additional functions. You can read the values that you have set in the display.



Button	Use
 Time setting options	Selects the timer  , cooking time  , end time  or clock  .
 Childproof lock	Locks and unlocks the control panel.
- Minus	Decreases set values.
+ Plus	Increases set values.

The time setting option that is currently selected in the display is indicated by the brackets [] around the corresponding symbol.

Exception: for the clock, the  symbol only lights up when you are making changes.



Function and temperature selector

Using the function and temperature selector, set the heating type and temperature in the  main oven.

Setting	Use
● Off position	The main oven is switched off.
 3D hot air* 50 - 270 °C	For cakes and pastries on one or more levels. The fan distributes the heat of the ring heating element in the rear wall evenly throughout the cooking compartment.
 Defrost	For defrosting, e.g. meat, poultry, bread and cakes. The fan circulates the warm air around the dish.
 Oven light	Switches on the oven light.





* The type of heating used to determine the energy efficiency class in accordance with EN50304.

When you make settings, the oven light in the cooking compartment switches on.

When the main oven is heating, the  symbol lights up in the display. It goes out during pauses in the heating. For the  Defrost type of heating, the symbol does not light up.

Function selector

Use the function selector to select the type of heating for the  top oven.



Setting	Use
 Off position	The top oven is switched off.
 Top/bottom heat*	For cakes, bakes and lean joints of meat, e.g. beef or game, on one level. Heat is emitted evenly from the top and bottom.
 Grill, large area	For grilling steaks, sausages, bread and pieces of fish. The entire area under the grill element becomes hot.
 Oven light	Switches on the oven light.

* The type of heating used to determine the energy efficiency class in accordance with EN50304.

When you make settings, the oven light in the cooking compartment switches on.

Temperature selector

Use the temperature selector to set the temperature or grill setting in the  top oven.

Setting	Meaning
 Off position	The top oven is not heating.
50-270 Temperature range	The temperature in the cooking compartment in °C.
I, II, III Grill settings	The grill settings for the  Grill, large area. I = level 1, low II = level 2, medium III = level 3, high

When the top oven is heating, the  indicator lamp for the temperature lights up. It goes out during heating pauses.

Cooking compartment

Oven light

The oven light is located in the cooking compartment. A cooling fan protects the oven from overheating.

During operation, the oven light in the cooking compartment is on. The  setting on the function selector can be used to switch on the light without heating the oven.

Cooling fan

The cooling fan switches on and off as required. The hot air escapes above the door. Caution. Do not cover the ventilation slots. Otherwise the oven will overheat.

So that the cooking compartment cools down more quickly after operation, the cooling fan continues to run for a certain period afterwards.

Accessories

You can pull out the accessories two thirds of the way without them tipping. This allows meals to be removed easily.

The accessories can become deformed when they become hot. As soon as they have cooled down, the deformation disappears with no effect on the function.

main oven

The accessories can be inserted into the oven at 3 different levels.



top oven

The accessories can be inserted into the oven at 2 different levels.

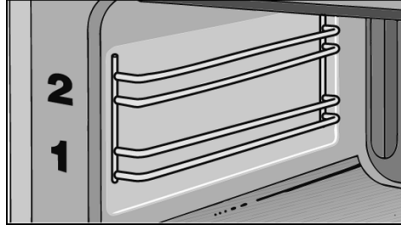

You can buy accessories from the after-sales service, from specialist retailers or online. Please specify the HEZ number.

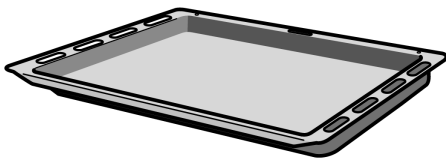

Universal pan

For moist cakes, pastries, frozen meals and large roasts. It can also be used to catch dripping fat when you are grilling directly on the wire rack.

Slide the universal pan into the oven with the tapered edge facing the oven door.

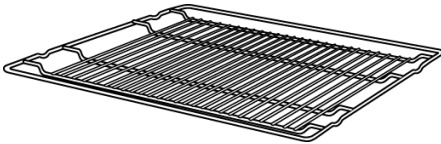

2 x wire rack

For cookware, cake tins, roasts, grilling and frozen meals.

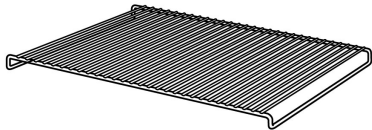

Insert shelf

For roasting. Always place the shelf in the universal pan. This ensures that dripping fat and meat juices are collected.

Special accessories

You can purchase special accessories from the after-sales service or specialist shops.

You will find a comprehensive range of products for your oven in our brochures and on the Internet.

The availability of special accessories and whether it is possible to order them online may vary depending on your country. Please see the sales brochures for more details.

Pizza tray HEZ 317000	Ideal for pizza, frozen foods or large round cakes. You can use the pizza tray instead of the universal pan. Place the baking tray on the grid and proceed according to the details in the tables.
Insert shelf HEZ 324000	For roasting. Always place the shelf in the universal pan. This ensures that dripping fat and meat juices are collected.
Grill tray HEZ 325000	Use for grilling in place of the wire shelf or as a splatter guard, so that the oven does not become very dirty. Only use the grill tray in the universal pan. Grilling on the grill tray: Only use in the shelf positions 1, 2 and 3. The grill tray as a splash guard: Insert the universal pan with the grill tray under the wire shelf.
Enamel baking tray HEZ 331000	For cakes and biscuits.
Enamel baking tray with non-stick coating HEZ 331010	Cakes and biscuits can be removed more easily from the baking tray. Push the baking tray into the oven with the sloping edge facing towards the oven door.
Universal pan HEZ 332000	For moist cakes, pastries, frozen meals and large roasts. It can also be used to catch dripping fat when you are grilling directly on the wire rack.
Universal pan with non-stick coating HEZ 332010	Cakes and biscuits can be removed more easily from the baking tray. Push the baking tray into the oven with the sloping edge facing towards the oven door.
Wire shelf HEZ 334000	For ovenware, cake tins, roasts, grilling and frozen meals.
Glass pan HEZ 336000	A deep baking tray made of glass. Can also be used as a serving dish.

3-fold telescopic shelves HEZ 338307	The pull-out rails at levels 1, 2 and 3 allow you to pull accessories out further without them tipping.
Protective device for oven door 672942	Prevents the oven door from being touched accidentally from the outside while the appliance is in operation.
After-sales service products	You can obtain suitable care and cleaning agents and other accessories for your domestic appliances from the after-sales service, specialist retailers or (in some countries) online via the e-Shop. Please specify the relevant product number.
Cleaning cloths for stainless-steel surfaces product no. 311134	Reduces the build-up of dirt. Impregnated with a special oil for perfect maintenance of your appliance's stainless-steel surfaces.
Oven and grill cleaning gel product no. 463582	For cleaning the cooking compartment. The gel is odourless.
Microfibre cloth with honeycomb structure product no. 460770	Especially suitable for cleaning delicate surfaces, such as glass, glass ceramic, stainless steel or aluminium. The microfibre cloth removes liquid and grease deposits in one go.
Door lock product no. 612594	To prevent children from opening the oven door. Depending on the design of the appliance door, the lock will be screwed on differently. Observe the information on the supplement sheet that comes with the door lock.

Before using the appliance for the first time

Here, you will find out what you have to do before preparing food with your oven for the first time. Read the *Safety information* section beforehand.

Setting the clock



Once you have connected the appliance, the  symbol and four zeros light up in the display. Set the time.

1. Press the  button
The time 12:00 is shown in the display.
2. Use the **+** or **-** button to set the clock.



After a few seconds, the time set is adopted.

Heating up the oven

To get rid of the new cooker smell, heat up the oven when it is empty and closed.

One hour with  3D hot air or  Top/bottom heat at 240 °C is ideal.

Make sure that there are no packaging remains in the cooking compartments.

1. Use the function selector to set  Top/bottom heat.
2. Use the temperature selector to set the temperature to 240 °C.
3. Using the function and temperature selectors, set 240 °C and  3D hot air.

Turn the oven off after one hour. To do so, turn all function and temperature selectors to the off position.

Cleaning accessories

Before using the accessories for the first time, clean them thoroughly using hot, soapy water and a soft cloth.

Setting the oven

There are various ways in which you can set your oven. In it, we will explain how you can select the desired type of heating and temperature or grill setting.

You can select the oven cooking time and end time for your dish. Please refer to the section on *Setting the time setting options*.

Type of heating and temperature

main oven

Using the function and temperature selectors, set a temperature for  3D hot air mode.

Turn the function and temperature selector to the  position to set the Defrost setting.

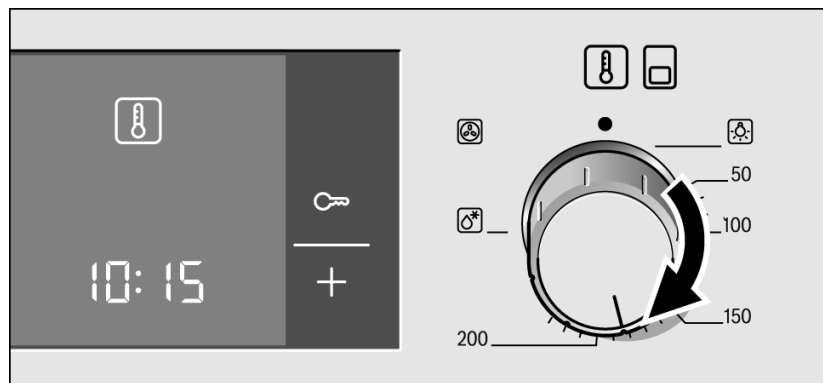

The main oven begins to heat up.

top oven

Example in fig.: Top/bottom heat at 200 °C.

1. Use the function selector to set the type of heating.

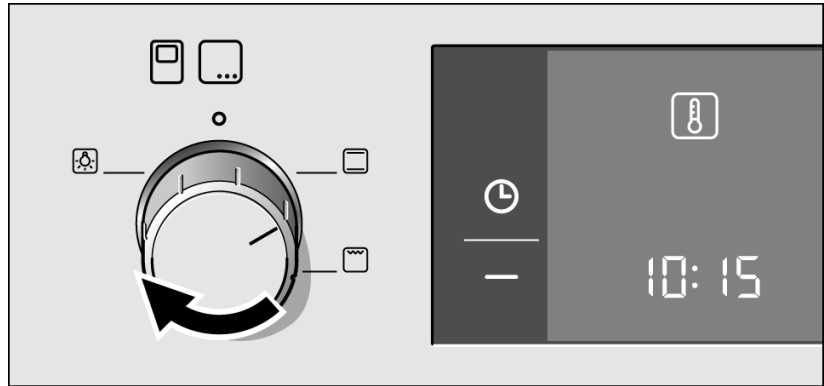

2. Set the temperature or grill setting using the temperature selector.

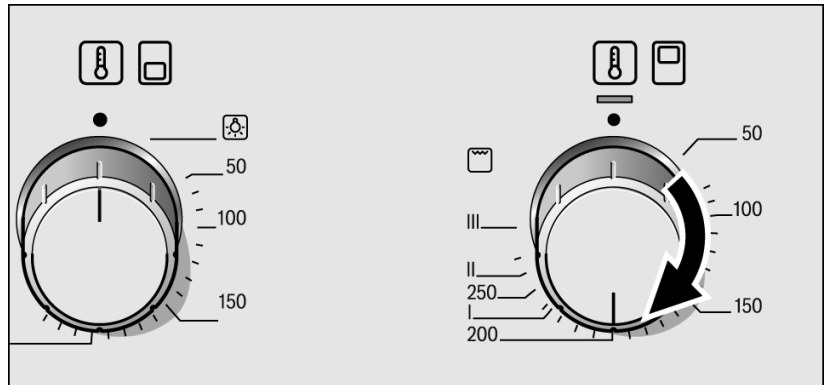

The top oven begins to heat up.



Switching off the oven

Turn the function and temperature selector to the off position.

Changing the settings



The type of heating and temperature or grill setting can be changed at any time with their respective selectors.

Setting the time-setting options

The  main oven has various time-setting options. You can use the  button to access the menu and switch between the individual options. All the time symbols are lit during the time when you can make settings. The brackets [] show you which time-setting options you have currently selected. A time-setting option which has already been set can be changed directly with the **+** or **-** button, when its time symbol is in brackets.

Timer

You can use the timer as a kitchen timer. It runs independently of the cooking compartment. The timer has its own signal. In this way, you can tell whether it is the timer or a cooking time which has elapsed.

1. Press button  once.
The time symbols light up in the display, and the brackets are around .
2. Set the timer duration with buttons **+** or **-**.
Button **+** default value = 10 minutes
Button **-** default value = 5 minutes

After a few seconds, the duration set is adopted. The timer starts. In the display, symbol [] lights up and the timer period starts to run down. The other time symbols go out.

The timer duration has elapsed

A signal sounds. 00:00 is showing in the display. Switch off the timer with button .

Changing the timer period





Use button **+** or **-** to change the timer duration. After a few seconds, the change will be adopted.

Clearing the timer period

Use button **-** to switch the timer duration back to 00:00. After a few seconds, the change will be adopted. The timer is switched off.

Calling up the time settings



If several time settings have been set, the corresponding symbols light up in the display. The timer runs in the foreground. Symbol  is in brackets and the timer period starts to run down.

To call up the timer , cooking time , end time  or clock , press button  repeatedly until the brackets are around the relevant symbol. The value is shown on the display for a few seconds.

Cooking time

You can set a cooking time for your dish in the  main oven. When the cooking time has elapsed, the main oven switches itself off automatically. This means that you do not have to interrupt other work to switch off the main oven. The cooking time cannot be accidentally exceeded.

Example in fig.: Cooking time of 45 minutes.

1. Turn the function and temperature selector to set the heating type and temperature for the main oven.
2. Press the  button twice.
00:00 is shown in the display. The time symbols light up, the brackets are around .

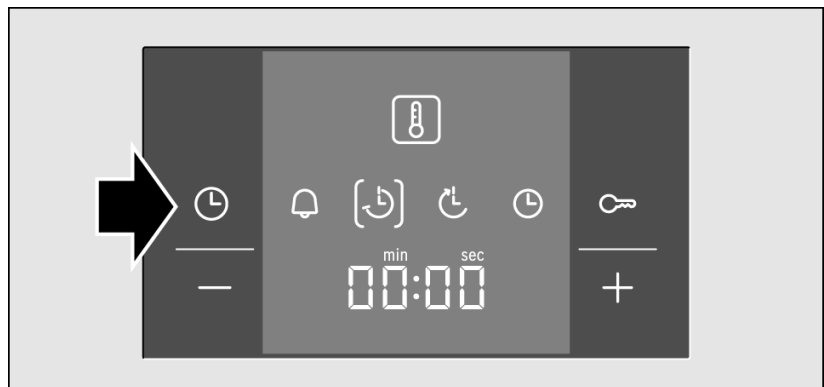

- Use the **+** or **-** button to set the cooking time.
 - +** button default value = 30 minutes
 - button default value = 10 minutes



The main oven will start up after a few seconds. In the display, the timer period counts down and the symbol [⌚] lights up. The other time symbols go out.

The cooking time has elapsed

A signal sounds. The main oven stops heating. 00:00 is shown in the display. Press the ⌚ button. The **+** or **-** button can be used to set a new cooking time. Or press the ⌚ button twice and turn the function and temperature selector to the off position. The main oven is switched off.

Changing the cooking time

Use the **+** or **-** button to change the cooking time. After a few seconds, the change is adopted. If the timer has been set, first press the ⌚ button.

Cancelling the cooking time

Use the **-** button to set the cooking time back to 00:00. After a few seconds, the change is adopted. The cooking time is cancelled. If the timer has been set, first press the ⌚ button.

Checking the time settings

If several time-setting options are set, the relevant symbols are illuminated on the display. The time-setting option symbol that is currently activated is surrounded by brackets.

To check the ⌚ timer, ⌚ cooking time, ⌚ end time or ⌚ clock, press the ⌚ button repeatedly until the brackets are around the relevant symbol. The display shows the value for a few seconds.

End time



You can delay the time at which you wish your dish to be ready. The  main oven starts automatically and is finished at the desired time.

You can, for example, put your dish in the oven in the morning and set the cooking time so that it is ready at lunch time.

Ensure that food is not left in the cooking compartment for too long as it may spoil.

Example in fig.:





it is 10:30, the cooking time is 45 minutes and the main oven is required to finish cooking at 12:30.

1. Turn the function and temperature selector to set the heating type and temperature for the main oven.
2. Press the  button twice.
3. Use the **+** or **-** button to set the cooking time.
4. Press the  button
The brackets are around . The time when the dish will be ready is displayed.



5. Use the **+** or **-** button to delay the end time.



After a few seconds, the oven adopts the settings and switches to standby position. The display shows the time at which the dish will be ready and the  symbol is in brackets. The  and  symbols go out. When the main oven starts, the cooking time counts down in the display and the  symbol is shown in brackets. The  symbol goes out.

The cooking time has elapsed

A signal sounds. The main oven stops heating. 00:00 is shown in the display.

Press the  button. The **+** or **-** button can be used to set a new cooking time.

Or press the  button twice and turn the function and temperature selector to the off position.

The main oven is switched off.

Changing the end time

Use the **+** or **-** button to change the end time.

After a few seconds, the change is adopted.

If the timer has been set, first press the  button twice.

Do not change the end time if the cooking time has already started to elapse. The cooking result would no longer be correct.





Cancelling the end time

Use the **-** button to set the end time back to the current time. After a few seconds, the change is adopted. The main oven starts.

If the timer has been set, first press the  button twice.

Checking the time settings

If several time-setting options are set, the relevant symbols are illuminated on the display. The time-setting option symbol that is currently activated is surrounded by brackets.

To check the  timer,  cooking time,  end time or  clock, press the  button repeatedly until the brackets are around the relevant symbol. The display shows the value for a few seconds.

Time



After the appliance is connected or after a power cut, the  symbol lights up in the display with four zeros. Set the time.

1. Press the  button.
The time 12:00 is shown in the display.
2. Set the time with the **+** or **-** button.

After a few seconds, the time set is adopted.

Changing the time

No other time function should be set.

1. Press the  button four times.
The time symbols light up in the display and brackets are around .
2. Change the time with button **+** or **-**.

After a few seconds, the time set is adopted.

Hiding the clock

You can hide the clock. Please refer to the section on *Changing the basic settings*.

Childproof lock

The  main oven has a childproof lock to prevent children from switching it on by accident or changing a setting.

The main oven does not respond to any settings. You can still set the time and the timer when the childproof lock is activated.

If the heating type and temperature or grill setting are set for the main oven, the childproof lock interrupts the heater element.

Switching on the childproof lock

No cooking time or end time may be set.

Press and hold the  button for approx. 4 seconds.

The  symbol appears in the display. The childproof lock is activated.

Switching off the childproof lock

Press and hold the  button for approx. 4 seconds.

The  symbol in the display goes out. The childproof lock is deactivated.

Changing the basic settings

Your oven has various basic settings. These settings can be customised to suit your requirements.

Basic setting	Selection 1	Selection 2	Selection 3
c1 Clock display	always*	only with the ⌚ button	-
c2 Length of signal upon completion of a cooking time or timer period	approx. 10 secs	approx. 2 mins*	approx. 5 mins
c3 Waiting time until a setting is applied	approx. 2 secs	approx. 5 secs*	approx. 10 secs

* Factory setting

No other time-setting option should have been set.

1. Press and hold the ⌚ button for approximately 4 seconds. The display shows the current basic setting for the clock display, e.g. c1 1 for Selection 1.
2. Use the + or - button to change the basic setting.
3. Confirm with the ⌚ button.
The next basic setting appears in the display. All levels can be viewed using the ⌚ button, and changed with the + or - button.
4. To exit, press and hold the ⌚ button for approximately 4 seconds.

All basic settings are applied.

You may change the basic settings at any time.

Care and cleaning

With good care and cleaning, your oven will remain clean and fully-functioning for a long time to come. Here we will explain how to maintain and clean your oven correctly.

Notes

Slight differences in the colours on the front of the oven are caused by the use of different materials, such as glass, plastic and metal.

Shadows on the door panel which look like streaks, are caused by reflections made by the oven light.

Enamel is baked on at very high temperatures. This can cause some slight colour variation. This is normal and does not affect their function.

The edges of thin trays cannot be completely enamelled. As a result, these edges can be rough. This will not impair the anti-corrosion protection.

Cleaning agents

Damage to various surfaces caused by using the wrong cleaning agent can be avoided by observing the information in the table below.

Do not use

- sharp or abrasive cleaning agents,
- detergents with high concentrations of alcohol,
- hard scouring pads or sponges,
- high-pressure cleaners or steam cleaners.

Wash new sponge cloths thoroughly before use.

Area	Cleaning agents
Oven front	Use hot soapy water: Clean with a dish cloth and dry with a soft cloth. Do not use any glass cleaners or glass scrapers.
Stainless steel	Use hot soapy water: Clean with a dish cloth and dry with a soft cloth. Remove spots caused by limescale, fat, starch and egg white immediately. Corrosion can form under such flecks. Special stainless steel cleaning products suitable for warm surfaces are available from our after-sales service or from specialist retailers. Apply a thin layer of the cleaning product with a soft cloth.
Door panels	Glass cleaner: Clean with a soft cloth. Do not use a glass scraper.
Glass cover for the oven light	Use hot soapy water: Clean with a dish cloth.
Seal Do not remove.	Use hot soapy water: Clean with a dish cloth. Do not scour.
Shelves	Use hot soapy water: Soak and clean with a dish cloth or brush.
Accessories	Use hot soapy water: Soak and clean with a dish cloth or brush.

Cleaning the self-cleaning surfaces in the cooking compartment

The back panel and ceiling in the top oven and the back panel in the main oven are coated with self-cleaning enamel. This coating absorbs and disintegrates splashes from baking and roasting while the oven is in operation. The higher the temperature and the longer the oven is in operation, the better the result will be.

If dirt is still visible after several uses, clean the back wall and ceiling with hot soapy water and a soft sponge.

Discolouration may occur over time that cannot be removed. This does not damage the enamel.

Cleaning the cooking compartment floor and side walls

Important notes

Never use abrasive cleaning agents. You will scratch or destroy the coating.

Never treat the back wall or ceiling with oven cleaner. If oven cleaner accidentally gets on to the coating, remove it immediately with a soft sponge and plenty of water.

Use a dish cloth and hot soapy water or a vinegar solution.

If there are heavy deposits of dirt, use a stainless steel scouring pad or oven cleaner. Only use when the cooking compartment is cold.

Never treat the self-cleaning surfaces with a scouring pad or oven cleaner.

Cleaning hook-in racks



For easier cleaning, you can remove the hook-in racks.

Risk of burning due to hot elements in the cooking compartment. Wait until the cooking compartment has cooled down.

Remove hook-in rack

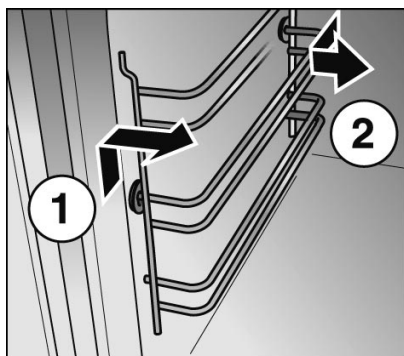

1. Push the hook-in rack upwards at the front and unhook to the side.
2. Pull the hook-in rack forwards at the rear and unhook to the side.

Cleaning hook-in racks

Clean hook-in racks with detergent and a sponge or brush.

Hanging hook-in racks

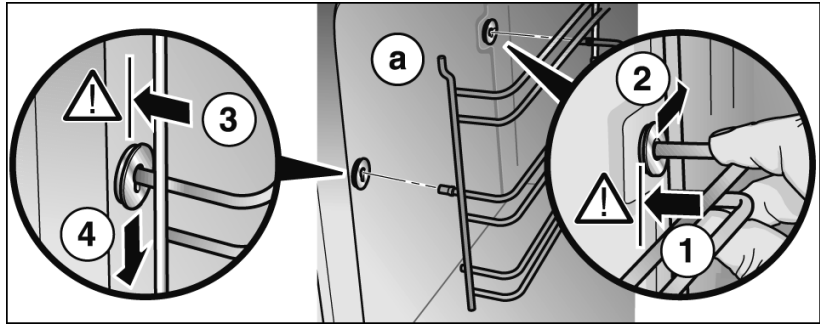

Always install the hook-in rack with the indentation (a) facing upwards, so that the shelf positions match.

1. Insert the hook-in rack at the rear until the limit stop.
2. Push the hook-in rack towards the rear.
3. Insert the hook-in rack at the front until the limit stop.
4. Push the hook-in rack downwards.

Detaching and attaching the oven door

For cleaning purposes and to remove the door panels, you can detach the oven door.

The oven door hinges each have a locking lever. When the locking levers are closed (Fig. A), the oven door is secured in place. It cannot be detached. When the locking levers are open in order to detach the oven door (Fig. B), the hinges are locked. They cannot snap shut.

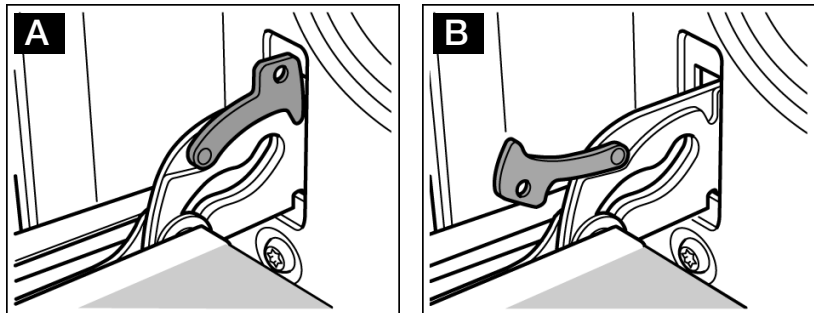



There is a risk of injury. Whenever the hinges are not locked, they snap shut with great force. Ensure that the locking levers are always fully closed or, when detaching the oven door, fully open.

Detaching the door

1. Open the oven door fully.
2. Open the locking levers on the left and right-hand sides (Fig. A).
3. Close the oven door up to the limit stop (Fig. B). Grip the door on the left and right-hand sides with both hands. Close the door a little more and pull it out.

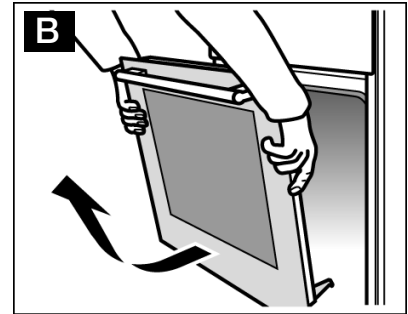
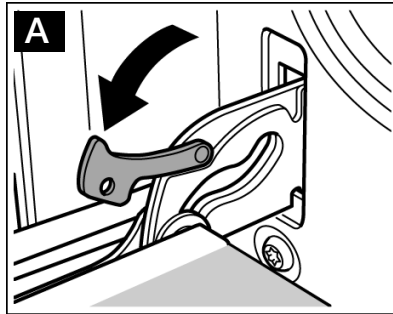

Attaching the door

Reattach the oven door in the reverse sequence to removal.

1. When attaching the oven door, ensure that both hinges are inserted straight into the opening (Fig. A).
2. The notch on the hinge must engage on both sides (Fig. B).

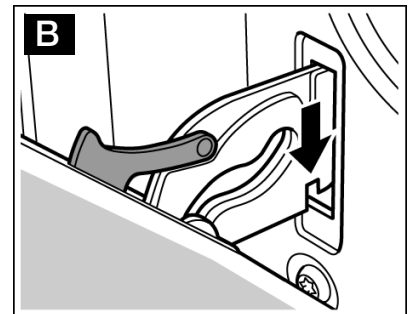
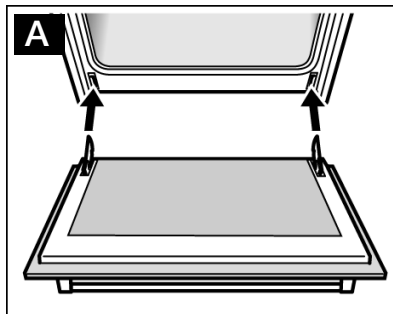

3. Close both locking levers again (Fig. C).
Close the oven door.

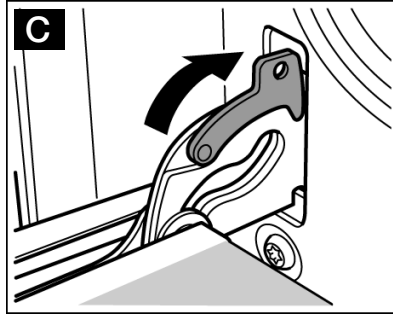

- ⚠ There is a risk of injury. If the oven door falls out accidentally or a hinge snaps shut, do not reach into the hinge.
Call the after-sales service.

Cleaning the door panels

To facilitate cleaning, you can remove the inner door panels from the appliance doors.

- ⚠ Risk of injury.
The components inside the appliance door may have sharp edges. Take care not to cut yourself.
Wear protective gloves.

Caution.

The appliance must not be used again until the door panels and appliance doors have been correctly refitted.

Before removing, make a note of the position in which the door panel is fitted, so that it is not refitted the wrong way round.

Removing the door panels

main oven and top oven

1. Unhook the appliance door and lay it on a soft, clean surface with the front side facing downwards (see section: Removing and fitting the appliance door).

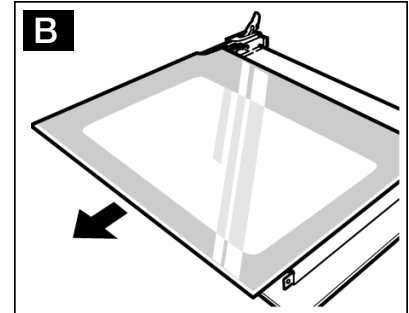
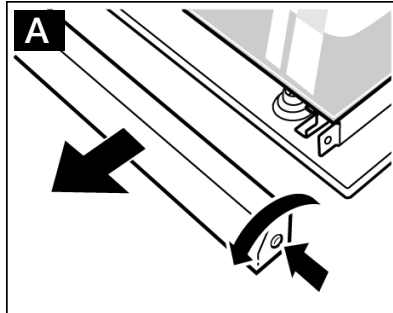

2. Unscrew the appliance door cover at the top on the left and right-hand side and remove it (Fig. A).
3. Lift the door panel and pull it out. (Fig. B).

top oven

In the upper oven, you can also remove and clean an intermediate panel.

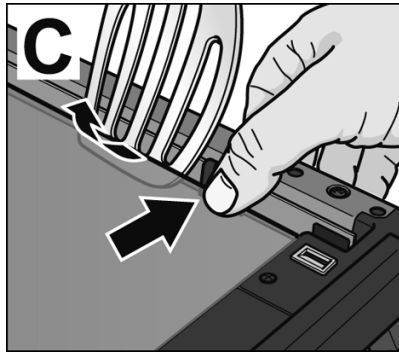

1. Press the intermediate panel holder on one side and disengage it with e.g. a spatula (Fig. C).
2. Disengage the other side in the same way and remove the intermediate panel.

Cleaning

Clean the panels with glass cleaner and a soft cloth.

Caution.

Do not use any sharp or abrasive medium or a glass scraper. The glass could become damaged.

Fitting the door panels

top oven

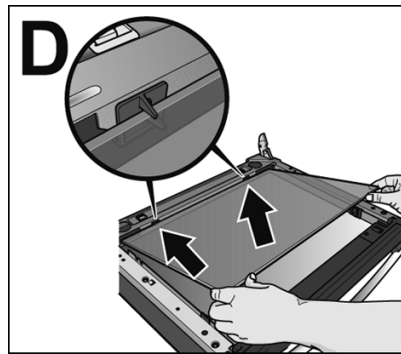

1. Insert the left and right-hand sides of the intermediate panel into the supports (Fig. D).
2. Press the intermediate panel down into the holders.

main oven and top oven

1. Slide in the door panel as far as the stop.
2. Fit the cover and screw it in place.
3. Refit the appliance door.

Troubleshooting

Malfunions often have simple explanations. Before you call the after-sales service, please try to rectify the fault yourself using the table.

Malfunction table

If a dish doesn't turn out as well as you had hoped, have a look in the *Tested for you in our cooking studio* section. There you will find many tips and information about cooking.

Problem	Possible cause	Remedy/information
The oven does not work.	Blown fuse.	Look in the fuse box and check that the fuse is in working order.
	Power cut.	Check whether the kitchen light or other kitchen appliances are working.
⌚ and zeros light up in the display.	Power cut.	Reset the clock.
The oven does not heat up.	There is dust on the contacts.	Turn the control knobs backwards and forwards several times.

Error messages

If an error message with **E** appears in the display, press the ⌚ button. The message disappears. Any time function that has been set is cleared.
If an error message does not disappear, call the after-sales service.

You can provide a remedy yourself for the following error message.

Error message	Possible cause	Remedy/information
E011	A button was pressed for too long or is covered.	Press all buttons individually. Check whether a button has jammed or is covered or dirty.



There is a risk of electric shock. Incorrect repairs are dangerous. Repairs may only be carried out by one of our experienced after-sales engineers.

Replacing the oven light

If the oven light bulb fails, it must be replaced. Spare bulbs can be obtained from the after-sales service or exclusive dealers.



Risk of electric shock. Disconnect the appliance from the power supply. Switch off the circuit breaker or take out the fuse in the household fuse box.

main oven

Only use these bulbs for the main oven:
E14, 230 - 240 V, 25 W, heat-resistant to 300 °C.

1. Unhook the hook-in rack on the left-hand side.
2. Place a tea towel in the cold cooking compartment to prevent damage.

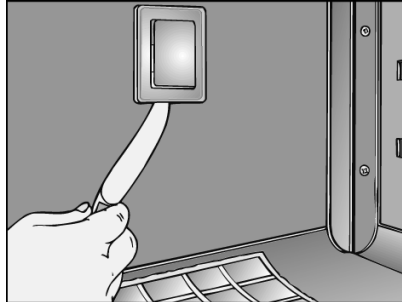

3. Remove the lamp cover. To do so, insert a knife or similar between the lamp cover and mounting frame.
4. Replace the bulb with one of the same type.
5. Insert the lamp cover in the mounting frame.
6. Hook in the hook-in rack.
7. Remove the tea towel and switch on the circuit breaker.

top oven

Only use these bulbs for the top oven:
E14, 220 - 240 V, 40 W, heat-resistant to 300 °C.

1. Place a tea towel in the cold cooking compartment to prevent damage.

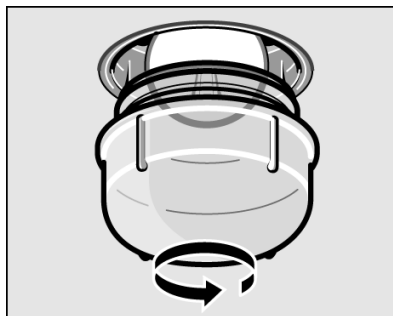

2. Turn the glass cover anticlockwise and remove it.
3. Replace the bulb with one of the same type.

4. Screw on the glass cover again.
5. Remove the tea towel and switch on the circuit breaker.

Glass cover

You must replace a damaged glass cover. Suitable glass covers may be obtained from the after-sales service. Please specify the E number and FD number of your appliance.

After-sales service

Our after-sales service is there for you if your appliance should need to be repaired. You will find the address and telephone number of your nearest after-sales service point in the phone book. The listed after-sales service centres will also be pleased to give you the details of an after-sales service point near you.

E number and FD number

Please quote the E number (product number) and the FD number (production number) of your appliance when contacting the after-sales service.

The rating plate containing these numbers is found on the right, on the side of the oven door.

You can make a note of the number of your appliance and the telephone number of the after-sales service in the space below to save time should it be required.

E no.	FD no.
-------	--------

After-sales service ☎

Energy and environment tips

Here you can find tips on how to save energy when baking and roasting and how to dispose of your appliance properly.

Saving energy

Only preheat the oven if this is specified in the recipe or in the operating instruction tables.

Use dark, black lacquered or enamelled baking tins. They absorb the heat particularly well.

Open the appliance door as little as possible during cooking, baking or roasting.

It is best to bake several cakes one after the other. The cooking compartment is still warm. This may reduce the baking time for the second cake.

For longer cooking times, you can switch the oven off 10 minutes before the end of the cooking time and use the residual heat to finish cooking.

Environmentally-friendly disposal



Dispose of packaging in an environmentally-friendly manner.

This appliance is labelled in accordance with European Directive 2002/96/EC on Waste Electrical and Electronic Equipment - WEEE.

The directive gives a framework for the collection and recycling of old appliances, which is valid across the EU.

Tested for you in our cooking studio

Here you will find a selection of dishes and the ideal settings for them. We will show you which type of heating and which temperature are best suited for your dish. You can find information about suitable accessories and the height at which they should be inserted. There are also tips about cookware and preparation methods.

Notes

Whether you should preheat or place food into a cold oven, is indicated in the respective sections.

Before using the appliance, remove all accessories from the cooking compartment that you will not be using.

Do not line the accessories with greaseproof paper until after they have been preheated.

The times specified in the tables are guidelines only. They will depend on the quality and composition of the food.

Use the accessories supplied. Additional accessories may be obtained from specialist retailers or from the after-sales service.

Always use oven gloves when taking hot accessories or ovenware out of the cooking compartment.

Cakes and pastries

Baking on one level

When baking with  3D hot air, note the following: cakes in tins and on baking trays should be inserted at shelf position 1.

Baking on two or more levels

Use  3D hot air.

Baking on 2 levels:

Wire rack or universal pan at shelf position 1

Baking tray at shelf position 3.

Baking trays that are placed in the oven at the same time will not necessarily be ready at the same time.

The tables show numerous suggestions for your dishes.

If you have 2 small, round cake tins, place them on one level diagonally on the wire rack.

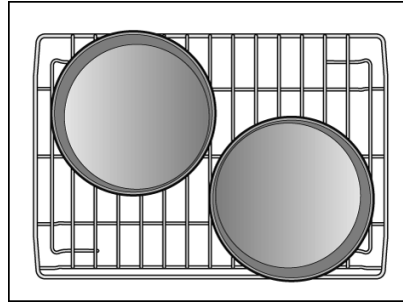

If you have 4 small, round cake tins, place 2 diagonally on each wire rack. Slide in the wire racks one above the other.

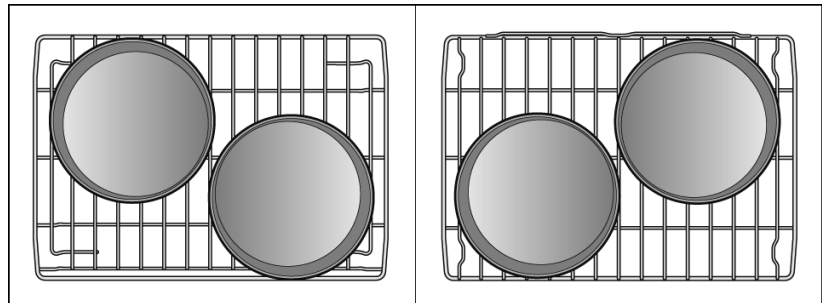

Baking tins

It is best to use dark-coloured metal baking tins.

When light-coloured baking tins made of thin metal or glass dishes are used, baking times are increased and cakes do not brown so evenly.

If you wish to use silicone backing tins, use the information and recipes provided by the manufacturer as a guide. Silicone backing tins are often smaller than normal tins. The amount of mixture and recipe instructions may differ.

Tables















The tables show the ideal type of heating for the various cakes and pastries.





The temperature and baking time depend on the amount and composition of the mixture. This is why

temperature ranges are given in the tables. You should try the lower temperature first, since a lower temperature results in more even browning. You can increase the temperature next time if necessary.

Additional information can be found in the “Baking tips” section following the tables.







main oven

Food	Dish	Shelf position	Type of heating	Temperature in °C	Baking time in minutes
Victoria Sandwich	Wire rack + 2x Ø 20 cm tins	1	 *	160-170	25-30
Light Fruit Cake	Wire rack + high Ø 20 cm tin	1	 *	140-150	80-100
Rich Fruit Cake	Wire rack + Ø 23 cm high round tin or 20 cm square tin	1	 *	140-150	210-240
Fruit crumble	Wire rack + flat glass dish	1	 *	160-170	40-50
Sponge cake (fatless)	Wire rack + baking tin (dark coated)	1	 *	160-170	25-35
Swiss Roll	Wire rack + Swiss roll tin	1	 *	180-190	10-15
Tart	Wire rack + Ø 20 cm plate or pie tin	1	 *	160-170	50-60
Quiche	Wire rack + quiche tin (dark coated)	1	 *	170-180	45-55
(White) Bread	Wire rack + loaf tin (1x 900g or 2x 450g)	1	 *	210-220	20-30
Scones	Universal pan	1	 *	180-200	8-10
Biscuits	Universal pan	1	 *	160-170	15-20
Small cakes	Wire rack + 12-cup tin	1	 *	160-170	20-25
Jam Tarts	Wire rack + 12-cup tin	1	 *	180-190	15-20
Meringues	Universal pan	1	 *	80	100-130

Food	Dish	Shelf position	Type of heating	Temperature in °C	Baking time in minutes
Pavlova	Universal pan	1	 **	150**+ 90	80-100
Pie	Wire rack + pie dish	1	 *	170-180	70-80
Yorkshire Pudding	Universal pan + 12-cup tin	1	 *	200-220	10-15
Jacket Potatoes	Universal pan	1	 *	160-170	60-70
Pizza (homemade)	Universal pan	1	 *	210-220	20-30







* preheat

** preheat at higher temperature, then reduce and insert food

Food	Dish	Shelf position	Type of heating	Temperature in °C	Baking time in minutes
Victoria Sandwich 2 levels	2 wire racks + 4x Ø 20 cm tins	3+1	 *	160-170	25-30
Scones 2 levels	wire rack with baking tray + Universal pan	3+1	 *	180-200	8-12
Biscuits 2 levels	wire rack with baking tray + Universal pan	3+1	 *	160-170	15-20
Small Cakes 2 levels	2 wire racks + 2x 12-cup tins	3+1	 *	150-160	20-30
Jacket Potatoes 2 levels	2 wire racks	3+1	 *	160-170	65-75
Pizza (homemade)	wire rack with baking tray + Universal pan	3+1	 *	180-190	35-45

* preheat

top oven

Food	Dish	Shelf position	Type of heating	Temperature in °C	Baking time in minutes
Victoria sandwich	Wire rack + 1x Ø 20 cm tin	1	 *	160-170	25-30
Scones	Wire rack + baking tray	1	 *	200-210	10-12
Small cakes	Wire rack + 12-cup tin	1	 *	160-170	25-30
Jamtartes	Wire rack + 12-cup tin	1	 *	190-210	15-25
Swiss roll	Wire rack + Swiss roll tin	1	 *	190-200	10-15
Biscuits	Wire rack + baking tray	2	 *	170-180	15-20
Meringues	Wire rack + baking tray	1	 *	80	110-140

* preheat

Baking tips

You want to bake following your own recipe.

This way you will be able to establish whether the sponge cake is baked through.

The cake collapses.

The cake has risen in the middle but has sunk around the edge.

The cake goes too dark on top.

The cake is too dry.

Use similar items in the baking tables as a guide.

Approximately 10 minutes before the end of the baking time specified in the recipe, stick a cocktail stick into the cake at the highest part. If the cocktail stick comes out clean, the cake is ready.

Use less fluid next time or set the oven temperature 10 degrees lower. Observe the specified mixing times in the recipe.

Do not grease the edge of the springform cake tin. After baking, loosen the cake carefully with a knife.

Place it lower in the oven, select a lower temperature and bake the cake for a little longer.

When it is done, make small holes in the cake using a cocktail stick. Then drizzle fruit juice or an alcoholic drink over it. Next time, select a temperature 10 degrees higher and reduce the baking time.

The bread or cake (e.g. cheesecake) looks good but is sticky on the inside (soggy with wet streaks).

The cake is unevenly browned.

The bottom of a fruit cake is too light.

The fruit juice overflows.

Small baked products made out of yeast dough stick to one another when baking.

You were baking on several levels. The items on the top baking tray are darker than that on the bottom baking tray.

Condensation forms when you bake moist cakes.

Use slightly less fluid next time and bake for slightly longer at a lower temperature. For cakes with a moist topping, bake the base first. Sprinkle it with almonds or bread crumbs and then place the topping on top. Please follow the recipe and stick to the baking times.

Select a slightly lower temperature to ensure that the cake is baked more evenly. Greaseproof paper that protrudes over the food can affect the air circulation. For this reason, always cut the greaseproof paper to fit the baking tray.

Place the cake one level lower the next time.

Next time, use the deeper universal pan, if you have one.

There should be a distance of approx. 2 cm around each item. This gives enough space for the item to expand nicely and turn brown on all sides.

Always use hot air (🔥) to bake on more than one level. Baking trays that are placed in the oven at the same time will not necessarily be ready at the same time.

Baking may result in the formation of water vapour, which escapes via the door. The steam may settle and form water droplets on the control panel or on the fronts of adjacent units. This is a normal physical process.

Meat, poultry, fish

Notes regarding ovenware

The universal pan with insert wire rack is suitable for large roasts. You may also use any heat-resistant ovenware.

Glass ovenware is the most suitable. The lid of the roasting dish should fit well and close properly.

Add a little more liquid when using enamelled roasting dishes.

With roasting dishes made of stainless steel, browning is not so intense and the meat is somewhat less well cooked. Increase the cooking times.

Always place the ovenware in the centre of the wire rack.

Place hot glass ovenware on a dry mat after cooking. The glass could crack if placed on a cold or wet surface.

Tips for roasting

The information in the table applies to food placed in a cold oven and for meat taken directly from the refrigerator.

The joints of meat should weigh between 500 g and 2 kg.

Ensure that you always use the lower temperature, if the weight of the joint you wish to roast is high.

If there are several pieces of meat, calculate the roasting time using the weight of the heaviest piece of meat. The individual pieces of meat should be approximately the same size.

Meat













Turn pieces of meat halfway through the cooking time.





When the roast is ready, turn off the oven and allow it to rest for an additional 10 minutes. This allows better distribution of meat juices.

After cooking, wrap sirloin in aluminium foil and leave it to rest for 10 minutes in the oven.

For roast pork with a rind, score the rind in a crossways pattern, then lay the roast in the dish with the rind at the bottom.

 main oven

Meat	Dish	Shelf position	Type of heating	Temperature in °C	Time, min per 500g + add. Time
Beef					
Slow roast joint	Universal pan with wire insert	1		130-140	40+40
Top side Top rump	Universal pan with wire insert	1		160-170	30+25
Lamb					
Leg	Universal pan with wire insert	1		160-170	30+25
Shoulder (bone in)	Universal pan with wire insert	1		160-170	25+20
Shoulder (boned and rolled)	Universal pan with wire insert	1		170-180	25+25
Rack of lamb	Universal pan with wire insert	1		180-190	25+25
Pork					
Roast joint	Universal pan with wire insert	1		180-190	35+35
Loin joint	Universal pan with wire insert	1		170-180	30+30
Belly	Universal pan with wire insert	1		160-170	30+25
Gammon joint	Universal pan with wire insert	1		160-170	30+30
Poultry					
Chicken	Universal pan with wire insert	1		170-180	20+25
Chicken, portion	Universal pan with wire insert	1		190-200	20+25
Chicken, Quarter (a 450 g)	Universal pan with wire insert	1		180-190	20+25

Meat	Dish	Shelf position	Type of heating	Temperature in °C	Time, min per 500g + add. Time
Duck	Universal pan with wire insert	1		180-190	20+20
Turkey, crown	Universal pan with wire insert	1		160-170	15+15
Casserole					
Diced meat (beef, pork, lamb)	Wire rack + glass roasting dish with lid	2		140	120-150 total time
Braising steaks	Wire rack + glass roasting dish with lid	2		140	120-150 total time
Chicken	Wire rack + glass roasting dish with lid	2		140	60-90

Tips for grilling

Always grill with the oven door closed.

Place the food to be grilled directly on the wire rack. If you are grilling a single piece, the best results are achieved by placing it in the centre of the wire rack. The universal pan should also be inserted under it. The meat juices are collected in the pan and the oven is kept clean.











As far as possible, the pieces of food you are grilling should be of equal thickness. They will then brown evenly and remain succulent and juicy. Do not add salt to steaks until they have been grilled.



Turn grilled items after the specified time.

Whole fish must not be turned. Place the whole fish in the oven in the swimming position with the dorsal fin facing upwards. Placing a scored potato or a small oven-proof container in the stomach cavity of the fish will provide stability.

The grill element switches on and off continually. This is normal. The grill setting determines how frequently this will happen.

Please note the information about preheating in the table.

Food	Dish	Shelf position	Type of heating	Grill setting	Time in minutes
Beef					
Steaks height 2-3 cm	Wire rack + universal pan	2+ 1	 *	3	1. side 10-13 2. side 6-8
Burgers height 1-2 cm	Wire rack + universal pan	2+ 1		3	1. side 10-12 2. side 6-8
Lamb					
Steaks height 2-3 cm	Wire rack + universal pan	2+ 1	 *	3	1. side 6-8 2. side 4-6
Chops height 2-3 cm	Wire rack + universal pan	2+ 1	 *	3	1. side 7-9 2. side 5-8
Pork					
Steaks height 1-2 cm	Wire rack + universal pan	2+ 1	 *	3	1. side 9-12 2. side 6-8
Chops height 2-3 cm	Wire rack + universal pan	2+ 1	 *	3	1. side 10-13 2. side 8-12
Burgers height 1-2 cm	Wire rack + universal pan	2+ 1		3	1. side 10-12 2. side 6-8
Sausages Ø 2-4 cm	Wire rack + universal pan	2+ 1		3	14-18**
Chicken					
Drumsticks each 150g	Wire rack + universal pan	2+ 1		3	1. side 16-20 2. side 12-15
Breast, boneless each 150g	Wire rack + universal pan	2+ 1		3	1. side 13-15 2. side 8-10

Food	Dish	Shelf position	Type of heating	Grill setting	Time in minutes
Fish					
Whole trout each 300g	Wire rack + universal pan	2+ 1		2	25-30
Fillets each 150g	Wire rack + universal pan	2+ 1		2	15-20
* Preheat for 3 minutes					
** Turn frequently					

Tips for roasting and grilling

The table does not contain information for the weight of the joint.

How to tell when the roast is ready.

The roast is too dark and the crackling is partly burnt.

The roast looks good but the juices are burnt.

The roast looks good but the juices are too clear and watery.

Steam rises from the roast when basted.

Select the next lowest weight from the instructions and extend the time.

Use a meat thermometer (available from specialist shops) or carry out a "spoon test". Press down on the roast with a spoon. If it feels firm, it is ready. If the spoon can be pressed in, it needs to be cooked for a little longer.

Check the shelf position and temperature.

Next time, use a smaller roasting dish or add more liquid.

Next time, use a larger roasting dish and use less liquid.

This is normal and due to the laws of physics. The majority of the steam escapes through the steam outlet. It may settle and form condensation on the cooler switch panel or on the fronts of adjacent units.

Preprepared products

Observe the instructions on the packaging.









The cooking result greatly depends on the quality of the food. Pre-browning and unevenness can sometimes even be found on the raw product.





If you line the accessories with greaseproof paper, make sure that the paper is suitable for these temperatures. Make sure the paper is a suitable size for the dish to be cooked.

Leave a little space between bread rolls when crisping them up. Do not place too many bread rolls on the accessories.

Sprinkle grated cheese over the top of your lasagne to give it a beautiful and evenly browned finish.

main oven

Food	Dish	Shelf position	Type of heating	Temperature in °C	Time in minutes
Pizza, frozen					
Pizza with a thin base	Universal pan	1	 *	190-200	15-20
Pizza with a thick base	Universal pan	1	 *	180-190	20-25
Pizza baguette	Universal pan	1	 *	170-180	25-30
Pizza, chilled	Universal pan	1	 *	200-210	10-15
Potato products, frozen					
Chips	Universal pan	1	 *	190-200	25-30
Duchess potatoes	Universal pan	1	 *	180-190	20-25
Hash browns (fried potatoes), Filled potato skins	Universal pan	1	 *	180-190	20-25
Potato wedges	Universal pan	1	 *	180-190	20-25
Baked goods, frozen					
Rolls, baguettes	Universal pan	1	 *	180-190	10-20

Food	Dish	Shelf position	Type of heating	Temperature in °C	Time in minutes
Fried foods, frozen					
Fish fingers	Universal pan	1	 *	180-200	15-20
Food, frozen					
Lasagne, 400g	Wire rack	1	 *	180-190	35-40
Lasagne, 1200g	Wire rack	1	 *	180-190	40-50
Food, chilled					
Lasagne, 400g	Wire rack	1	 *	170-180	35-40
Lasagne, 1200g	Wire rack	1	 *	170-180	40-45
* preheat					

Special dishes



Yoghurt

Bring the milk (3.5 % fat) to the boil, cool down to 45 °C. Stir in 150 g of yoghurt. Pour into cups or small screw-lid jars, cover, then place on the wire rack. Preheat for 5 minutes to 50 °C, then prepare as indicated.

Proving dough

Prepare the yeast dough as per usual. Place it in a heat-resistant ceramic dish and cover. Preheat the cooking compartment for 5-10 minutes. Switch off the appliance and leave the dough to prove in the cooking compartment.

Preparation

Dish	Ovenware	Level	Type of heating	Temperature in °C	Duration
Yoghurt	Place the cups or screw-lid jars on the wire rack	1		switch on the  oven light	6-8 hrs
Proving dough	Heat-resistant dish	Place on the cooking compartment floor		Preheat to 50 °C, switch off the appliance, place the yeast dough in the cooking compartment	5-10 mins
					20-30 mins

Defrosting

Take frozen food out of its packaging and place in a suitable dish on the wire rack.

Please observe the instructions on the packaging.

The defrosting time will depend on the type and quantity of the food.

Place poultry on a plate with the breast side facing down.

Frozen food	Accessories	Level	Type of heating	Temperature in °C
e.g. cream cakes, buttercream cakes, gateaux with chocolate or sugar icing, fruit, chicken, sausage and meat, bread and bread rolls, cakes and other baked items	Wire rack	1		The temperature selector remains switched off

Drying

Use unblemished fruit and vegetables only and wash it thoroughly.





Drain off the excess water, then wipe it dry.

Slide the universal pan in at shelf position 1 and the wire rack at shelf position 3.

Line the universal pan and the wire rack with greaseproof or parchment paper.

Turn very juicy fruit or vegetables several times.

Remove fruit and vegetables from the paper as soon as they have dried.

Dish	Level	Type of heating	Temperature in °C	Cooking time, hours
600 g of apple rings	1+3		80	approx. 5
800 g of pear slices	1+3		80	approx. 8
1.5 kgs of damsons or plums	1+3		80	approx. 8-10
200 g of herbs, washed	1+3		80	approx. 1½

Acrylamide in foodstuffs

Which foods are affected?

Acrylamide is mainly produced in grain and potato products heated at high temperatures, such as potato crisps, chips, toast, rolls, bread, fine baked goods (biscuits, gingerbread, cookies).

Tips for keeping acrylamide to a minimum when preparing food

General

Keep cooking times to a minimum.
Cook meals until they are golden brown, but not too dark.
Large, thick pieces of food contain less acrylamide.

Baking

Maximum 200 °C with top/bottom heating, maximum 180 °C with 3D hot air or hot air.

Biscuits

Maximum 190 °C with top/bottom heating, maximum 170 °C with 3D hot air or hot air.
Egg or egg yolk reduces the production of acrylamide.

Oven chips

Spread out a single layer evenly on the baking tray. Bake at least 400 g per baking tray so that they do not dry out.

Test dishes

These tables have been produced for test institutes to facilitate the inspection and testing of the various appliances.

In accordance with EN/IEC 60350.

Baking

When baking on 2 levels at once, always insert the universal pan above the baking tray.

When baking on 3 levels at once, always insert the universal pan in the centre of the oven.

Apple pie on 2 levels:

Place dark springform cake tins on top of one another.





Apple pie on 1 level:



Place dark springform cake tins in a diagonal line on the same level.

Springform cake tins made from tin plate:

Bake on 1 level with 3D-Hotair . Place the springform cake tins on the universal pan instead of the wire rack.

main oven

Dish	Accessories and ovenware	Level	Type of heating	Temperature in °C	Cooking time in minutes
Viennese whirls*	Baking tray	1		140-150	20-30
	Baking tray + Universal pan	3+1		140-150	20-30
Small cakes**	Baking tray	1		150-160	20-30
Small cakes**	Baking tray + Universal pan	3+1		150-160	25-35
Water sponge cake*	Springform cake tin on the wire rack	1		160-170	25-35

Dish	Accessories and ovenware	Level	Type of heating	Temperature in °C	Cooking time in minutes
Yeast cakes on a baking tray*	Universal pan	1		160-170	40-50
	Baking tray + Universal pan	3+1		150-170	50-60
Apple pie*	Wire rack + 2 dark springform cake tins, dia. 20 cm	1		170-180	70-80



* Preheat oven

** Preheat for 10 minutes

Grilling

If placing food directly on the wire rack, the universal pan should also be inserted at level 1. The liquid is collected here, keeping the oven cleaner.

top oven

Dish	Accessories and cookware	Level	Type of heating	Grill setting	Cooking time in minutes
Toast Preheat grill for 10 minutes	Wire rack	2		3	0.5-2
Beefburger, x 12* Do not preheat	Wire rack + Universal pan	2 1		3	25-30

* Turn after $\frac{2}{3}$ of the time.

